

MUTARS®



implantcast

Growing Prostheses

MUTARS® Xpand & BioXpand

Non-invasive growing prostheses

MUTARS® was developed in co-operation with Prof. Dr. W. Winkelmann (former director) and Prof. Dr. G. Gosheger (director), Clinic and Polyclinic for General Orthopedics and Tumororthopedics at the University Hospital of Münster, Germany.
MUTARS® Xpand and BioXpand was developed in co-operation with Prof. Dr. R. Baumgart, director of the Limb Lengthening Center Munich, Germany.
MUTARS® has been in successful clinical use since 1992.

Table of Contents

Table of Contents	3
Introduction	4
MUTARS® Xpand or BioXpand?	5
MUTARS® BioXpand	6
BioXpand treatment variants	10
MUTARS® Xpand	12
MUTARS® Xpand implants	16
MUTARS® Xpand instruments	21

Remark: All components of the MUTARS® Xpand and BioXpand prosthesis are customised implants which are planned, designed and manufactured for each patient based on a scaled x-ray.

Copyright note: MUTARS®, implaFix® HA, implatan® and implavit® are registered trademarks of implantcast GmbH. Using and/or copying the content of this brochure is only allowed with the prior written permission of implantcast.

FITBONE® is a registered trade mark of WITTENSTEIN intens GmbH.

Introduction

Since its introduction in 1992 the MUTARS® (**M**odular **U**niversal **T**umour **A**nd **R**evisi**O**n **S**ystem) has been successfully used for the treatment of major osseous defects of the lower and upper extremities. Its modular design was developed in cooperation with Univ.-Prof. Dr. W. Winkelmann (em. Director) and Univ.-Prof. Dr. G. Gosheger (Director), Department of General Orthopaedics and Orthopaedic Oncology at the University Hospital of Münster, Germany. The system has achieved good functional results and provides the surgeon with an individualised solution for major osseous defects, while bearing in mind the potential need for subsequent replacement of adjacent joints.

Endoprosthetic treatment of tumour patients represents a challenge for the surgeon and for the implant system. This is especially true when treating pre-adolescent patients as intramedullary implant fixation, while being stable, leads to reduced growth of the treated extremity / limb length discrepancy.

Most commercially available systems include lengthening modules which are elongated mechanically during surgical procedures. In order to reduce the exposure of the patients to several surgeries and rising the risk of infection, the MUTARS® Xpand prostheses follow a new concept. Based on an idea of Prof. Dr. R. Baumgart (Limb Lengthening Center Munich, ZEM-Germany) and in close collaboration with the company WITTENSTEIN intens GmbH (Igersheim) two new product systems (mechanical and biological) of growing prostheses have been developed: **MUTARS® Xpand and MUTARS® BioXpand.**

MUTARS® Xpand

The MUTARS® Xpand system was developed in order to provide an adequate treatment for children who suffer from deficiencies of the lower or upper extremities as a result of oncological disorders. All of the components in the MUTARS® Xpand range are customised implants which are planned, designed and manufactured for each individual patient based on a scaled x-ray. The purpose of the implant (aside from the preservation of the arm and/or leg itself) is to allow future non-surgical limb length corrections. The mechanical, non-invasive growing modules of the MUTARS® Xpand use a miniaturized, mechatronic actuator inside the prosthesis which is controlled by an extracorporeal energy coupling. Hence, invasive lengthening surgeries may be avoided, reducing the risk of infection. After the lengthening process the Xpand components need to be replaced by regular MUTARS® components.

MUTARS® BioXpand

The “biological” MUTARS® BioXpand growing prosthesis utilises an interim implant in the first instance. This will later be replaced by a lengthening nail (FITBONE®) when lengthening is actually required. Here the electromagnetic motor technology is used in a way which lengthens the bone of the patient so as to gain bone stock.

The “biological”, non-invasive BioXpand growing prosthesis is indicated for use in the long bones and is intended to stimulate bone growth of remaining bone stock post tumour resection. Using the principles of callus distraction (Page 5, Fig. 1 to 3) the interim prosthesis is replaced by a tumor prosthesis combined with a motorised lengthening nail (FITBONE®), an osteotomy is performed and the remaining bone can be lengthened. After the lengthening procedure the MUTARS® BioXpand components need to be replaced by conventional MUTARS® components.

NB: All components of the MUTARS® growing prostheses are customised implants. The lengthening treatment of the MUTARS® BioXpand itself is undertaken via consultation with Prof. Dr. R. Baumgart, ZEM-Germany in München.

MUTARS® Xpand or BioXpand?

MUTARS® Xpand or BioXpand?

The following overviews serve as a reference for easier decision making regarding MUTARS® Xpand and BioXpand. In general, each case has to be looked upon individually. Indications and contraindications need to be balanced against each other carefully. An adequate planning based on scaled x-rays and if necessary MRI Data is required for every case.

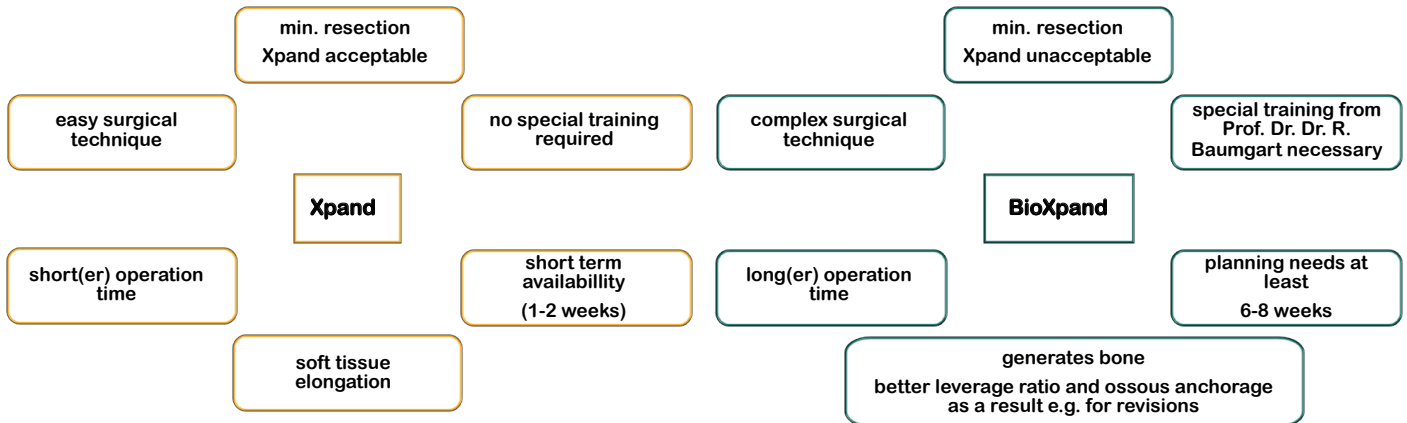

desired elongation	minimal resection		
	MUTARS® Xpand Prox. Femur	MUTARS® Xpand Dist. Femur	MUTARS® Xpand Prox. Tibia
≤ 50mm	180mm	170mm	170mm
> 50mm ≤ 75mm	205mm	195mm	195mm
> 75mm ≤ 100mm	230mm	220mm	220mm
> 100mm	I) surgery: Xpand (dummy or TAM) II) surgery: (elongation piece) + dummy/TAM exchange III) Repeat II until equal leg length		
Apart from the advantages of the BioXpand it can be seen as an alternative to the Xpand prosthesis, provided that the resection length is much shorter or the patient is quite young			
	MUTARS® BioXpand Prox. Femur	MUTARS® BioXpand Dist. Femur	MUTARS® BioXpand Prox. Tibia
min. resection	70mm	100mm	15mm
diameter / length FITBONE® TAA**	11/12/13mm 163 – 245mm		
max. elongation	80mm		

**custom-made devices in some cases possible

MUTARS® BioXpand - Principle of the callus-formation

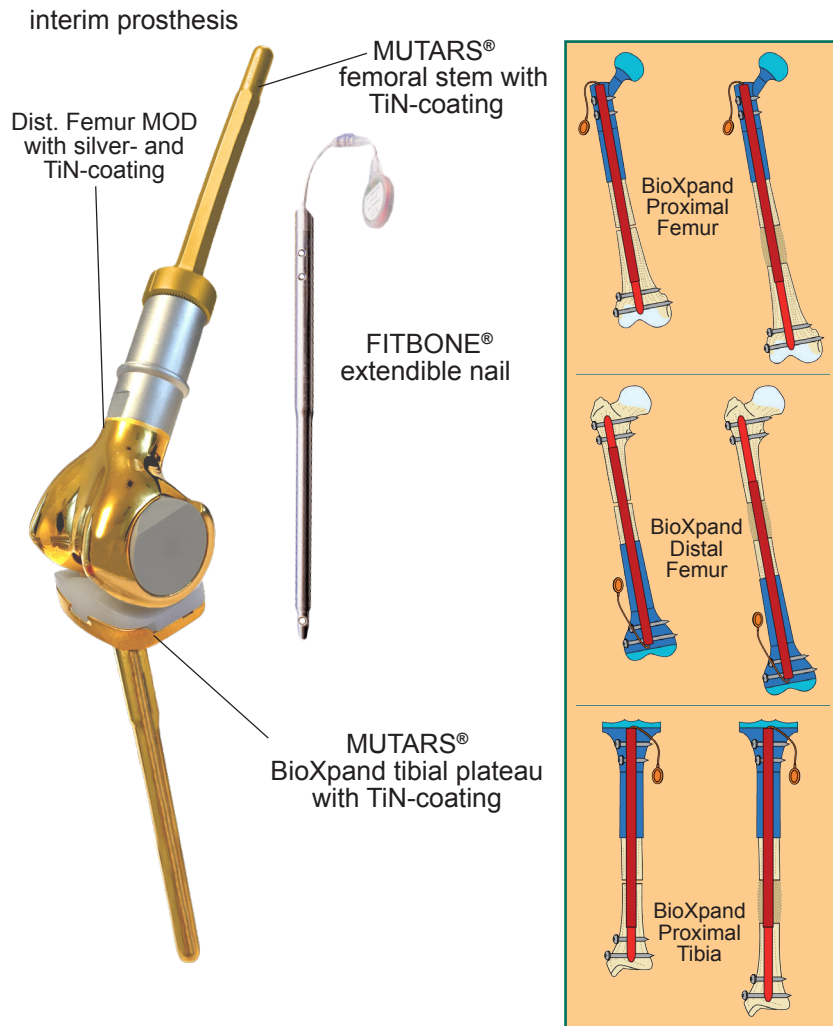

Fig. 1: Principle of the callus-formation with BioXpand

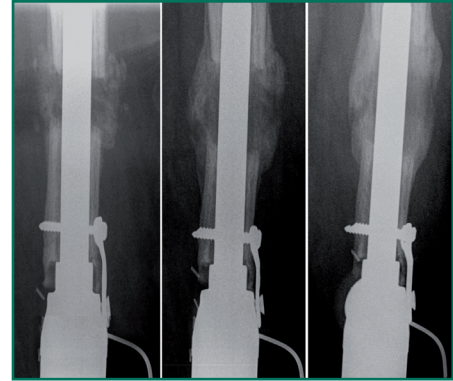

Fig. 2: Steps of callus formation (ZEM-Germany)

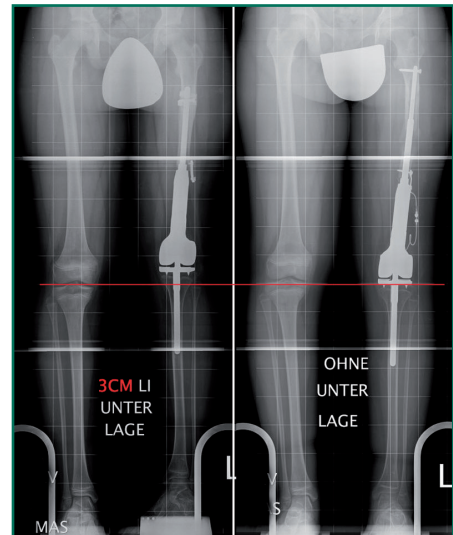

Fig. 3: Leg lengthening of 3cm with the BioXpand prosthesis (ZEM-Germany)

MUTARS® BioXpand product characteristics

The MUTARS® BioXpand prosthesis offers the option of lengthening via wireless energy transmission. The FITBONE® lengthening nail is built into the prosthesis which is controlled by an extracorporeal control unit (and electromagnetic energy transmitter). Lengthening itself is done non-surgically in 0.035mm steps without the risk of vascular injury, nerve injury and for that matter anaesthetic incident.

Planning and differences of a MUTARS® BioXpand I and II

A detailed planning based on scaled x-rays and the necessary resection and reconstruction length is fundamental to any MUTARS® BioXpand treatment. In the course of planning it has to be determined which type of MUTARS® BioXpand and which variant comes into use. MUTARS® BioXpand I and II differ fundamentally regarding the implantation of the FITBONE® lengthening nail. For MUTARS® BioXpand I (distal Femur) the FITBONE® lengthening nail is inserted from distal (through the knee) whereas for MUTARS® BioXpand II it is inserted minimally invasive from proximal. Therefore the BioXpand II is preferred for patients who require to be elongated more than once. The two variants (a and b) differ mainly regarding the use of an active FITBONE® lengthening nail or an interim prosthesis.

MUTARS® BioXpand I / II variant a

Indication: Existing or developing leg length discrepancies because of osseous deformities or tumors, bone replacement in the long bones.

This procedure requires at least three surgeries. After the tumour resection an interim prosthesis is implanted. The prosthesis has non-ingrowing stems and functions as placeholder until the patient has recovered and developed a noticeable leg length discrepancy. Afterwards the BioXpand I / II is implanted with a fully functional FITBONE® lengthening nail. The lengthening can take place right after the wound healing is finished. Eventually all components have to be replaced by a fitting MUTARS® prosthesis (BioXpand I) or the FITBONE® has to be exchanged (BioXpand II).

MUTARS® BioXpand I / BioXpand II variant b

Indication: Existing leg length discrepancies, bone replacement in the distal femur, no tumor present.

Variant a has the necessity of two surgeries. A MUTARS® BioXpand I or II is implanted with fully functional FITBONE® lengthening nail. The prosthesis is immediately ready for use and the lengthening process can be initiated right after the recovery of the patient. The prosthesis is to be replaced by one more suited for skeletally mature adults as soon as possible after the patient's growth phase is complete, e.g. MUTARS® distal Femur MK (BioXpand I). For the BioXpand II the FITBONE® has to be exchanged.

Advantages and disadvantages of BioXpand I and II

Regarding BioXpand I the FITBONE® lengthening nail is implanted through the knee joint. The surgical technique is fast and easy to learn. The placement of the FITBONE® lengthening nail with correct rotation and alignment is easy to realise. Using intraoperative x-rays is recommended for the placement of the cortical screws. The BioXpand I is therefore the procedure of choice for cases with just one elongation cycle and no change to another FITBONE® lengthening nail.

If it is already evident during the planning process that the stroke of one FITBONE® lengthening nail will not provide enough elongation to equalize the leg length discrepancy, then a BioXpand II should be used.

The placement of the FITBONE® lengthening nail is performed minimally invasive from proximal and not through the distal knee joint. While changing the FITBONE® lengthening nail, the correct rotation and alignment has to be checked. The more demanding surgical procedure of the BioXpand II has to be compared to the advantage of not opening the knee joint. This preserves the extremity concerned and reduces the potential risk of infection.

Lengthening process

Lengthening of no more than 1mm / day is undertaken according to the protocols of the manufacturer of the FITBONE® (WITTENSTEIN intens GmbH) for both the BioXpand I and II. The daily elongation has to be checked by the doctor in charge and adapted according to the callus formation. Even if soft tissue / extension problems should occur the lengthening process should not be interrupted, unless absolutely necessary. Otherwise the process of the callus formation cannot be continued later on. The lengthening at every stage has to be checked via confirmation x-rays. Also the number of induced electromagnetic impulses should be documented. If there is an expected growth of the healthy extremity, the affected extremity can be „overlengthened“ to compensate the growth of the healthy extremity but no more than the maximum stroke of the FITBONE® lengthening nail.

Termination of lengthening

As stated previously, lengthening may only be performed until the maximum stroke of the FITBONE® lengthening nail is reached. The maximum number of impulses can be found in the product specification and the MUTARS® BioXpand user information. The FITBONE® lengthening nail should be removed promptly after the termination of the prosthesis lengthening and the consolidation of the osteotomy. The prosthesis is to be replaced by one more suited for skeletally mature adults as soon as possible after the patient's growth phase is complete.

Maximal load of the prosthesis

This prosthetic system is intended for use in children and young adults. It has been made as slim as possible, hence the mechanical load carrying capacity is, quite naturally, limited. Details can be found in the FITBONE® surgical technique and depends on which variant of the FITBONE® is being used. During the distraction phase a partial weight bearing of max. 20kg is permissible. Overloading has to be avoided through the use of crutches for example. The physical activity can be increased gradually after the active elongation phase and sufficient ossification. Patients are to be informed that high levels of physical activity can negatively influence the longevity of the prostheses.

System components of an exemplary MUTARS® BioXpand prosthesis

- 1) MUTARS® BioXpand Distal Femur 170mm
(possible resection length >100mm)
- 2) FITBONE® TAA 1380 (elongation 80mm)
- 3) MUTARS® BioXpand screw M6x24mm
- 4) MUTARS® BioXpand tibial plateau
- 5) MUTARS® BioXpand L-plate left, right and T-plate
- 6) MUTARS® BioXpand screw M5x7,5mm
- 7) MUTARS® PEEK lock
- 8) MUTARS® PE-inlay

Note:

Every BioXpand prosthesis is a custom made implant which is planned and manufactured individually for each patient. Components may vary.

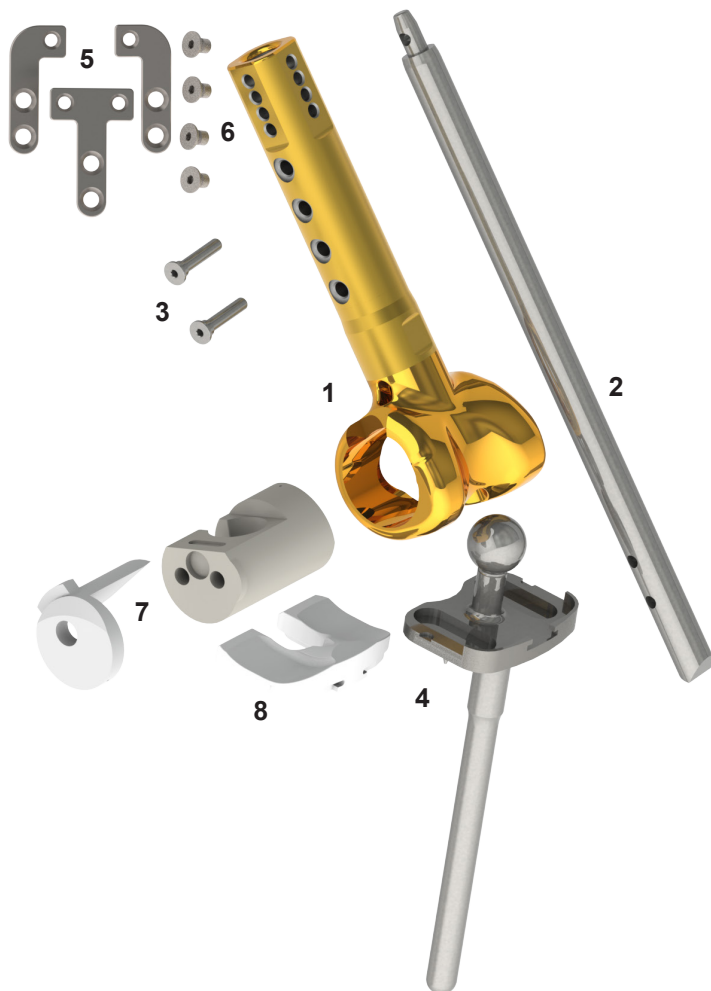

MUTARS® BioXpand Distal Femur 170mm

BioXpand treatment variant a

1. Operation



Interims prosthesis

- MUTARS® Distal Femur
- polished stems
- TiN coating

minimal ingrowth

2. Operation

MUTARS® BioXpand I

- FITBONE® lengthening nail (set from distal)
- polished tibial stem
- TiN coating

minimal ingrowth



MUTARS® BioXpand II

- FITBONE® lengthening nail (set from proximal)
- polished tibial stem
- TiN coating

minimal ingrowth



3. Operation

MUTARS® Distal Femur MK

- final tumour prostheses
- modular system
- fully hinged knee
- cemented and cementless stems
- 5 different tibial and femoral sizes



MUTARS® BioXpand II

- Exchange of the FITBONE® lengthening nail from proximal for further elongation

- MUTARS® BioXpand II stays in-situ



4. Operation

MUTARS® Distal Femur MK

- final tumour prostheses
- modular system
- fully hinged knee
- cemented and cementless stems
- 5 different tibial and femoral sizes



BioXpand treatment variant b

1. Operation

MUTARS® BioXpand I

active FITBONE®
set from distal
- polished tibial stem
- TiN coating

minimal ingrowth



MUTARS® BioXpand II

active FITBONE® lengthening nail
set from proximal
- polished tibial stem
- TiN coating

minimal ingrowth



2. Operation

MUTARS® Distal Femur MK

final tumour prostheses
- modular system
- fully hinged knee
- cemented and cementless stems
- 5 different tibial and femoral sizes



MUTARS® BioXpand II

Exchange of the FITBONE®
lengthening nail from proximal
for further elongation

- MUTARS® BioXpand II
stays in-situ



3. Operation

MUTARS® Distal Femur MK

final tumour prostheses
- modular system
- fully hinged knee
- cemented and cementless stems
- 5 different tibial and femoral sizes



MUTARS® Xpand

MUTARS® Xpand product characteristics

The MUTARS® Xpand modular prosthesis is telescopic and offers the option of lengthening via wireless energy transmission. An electric motor (and receiver), called TAM, is built into the prosthesis which is controlled by an extracorporeal control unit (and electromagnetic energy transmitter). Lengthening itself is done non-surgically in 0.035mm steps without the risk of vascular injury, nerve injury and for that matter anaesthetic incident. The MUTARS® Xpand can be implanted in a one stage or two stage surgery. Which means that the motor (TAM) can either be implanted right away or during a later surgery after a noticeable leg length discrepancy has occurred.

Planning of a MUTARS® Xpand prosthesis

The growing prosthesis can (as previously stated) either be implanted in one stage surgery if a limb length discrepancy is already existent, or in a second procedure after a length discrepancy presents. The potential elongation of the prosthesis varies between 50mm and 100mm dependent on the resection length. In order to develop a detailed plan it is essential to have scaled x-rays, to know the exact resection length and to decide whether a one or a two stage surgery is indicated.

MUTARS® Xpand surgical procedure

In the one stage surgery, after tumour resection, the definitive / functional TAM (as opposed to the dummy TAM) is implanted during this surgery. The prosthesis is immediately ready for use. The advantage of this procedure is that no additional surgery is needed to implant the engine of the prosthesis. The disadvantage however is that because of the relatively long idle time it is possible that the TAM won't work properly when needed. Reasons for this could be the ingrowth of soft tissue which prevents the TAM from elongating, or damage to the cable of the receiver through scar tissue and/or trauma. Also if the placement of the receiver is too deep it might interfere with the signal from the transmitter.

In the two stage surgery, after tumour resection, the appropriate length of dummy TAM (as opposed to the definitive / functional TAM) is implanted. Once the patient has recovered sufficiently and a length discrepancy has presented, the same length functional / definitive TAM is implanted during a second surgical procedure. Lengthening can then be started once wound healing has taken place. The advantage of a two stage approach is that the potential for tissue ingress within and / or mechanical damage to the TAM are less likely to occur as the TAM will be implanted for a shorter period of time before deployment. These advantages do however need to be balanced against the need for an additional surgery.

Lengthening process (post-OP)

Lengthening of no more than 1mm / day is undertaken according to the protocols of the manufacturer (WITTENSTEIN intens GmbH). In case of a one stage surgery, lengthening can always be done when a mismatch between both legs is noticeable. If soft tissue / extension problems should occur then the process can of course be interrupted at any time. Care should be taken not to exceed the maximum stroke of the TAM. Exceeding this limit can lead to the collapse of the TAM itself. The TAM should be removed promptly after the termination of the prosthesis lengthening. The prosthesis is to be replaced by one more suited for skeletally mature adults as soon as possible after the patient's growth phase is complete. Full weight bearing is possible for patients of up to 40kg. For patients heavier than 40kg partial weight bearing (via the use of crutches for example) is recommended for as long as the motor is in-situ.

MUTARS® Xpand

System components of an exemplary MUTARS® Xpand prosthesis

- 1) MUTARS® Xpand femoral stem cementless 10x120mm
- 2) MUTARS® Xpand screw M10x15mm
- 3) MUTARS® Xpand Distal Femur 160mm
(minimal resection length 170mm)
- 4) MUTARS® TAM special design 1650 (elongation 50mm)
- 5) Receiver 12V
- 6) MUTARS® Xpand PE-inlay for hinged knee
- 7) MUTARS® Xpand tibial joint for hinged knee incl. locking bolt
- 8) MUTARS® Xpand Distal Femur accessory kit (axle, locking screw, locking screw universal and PE locking plug)

Note:

Every Xpand prosthesis is a custom made implant which is planned and manufactured individually for each patient. Components may vary.

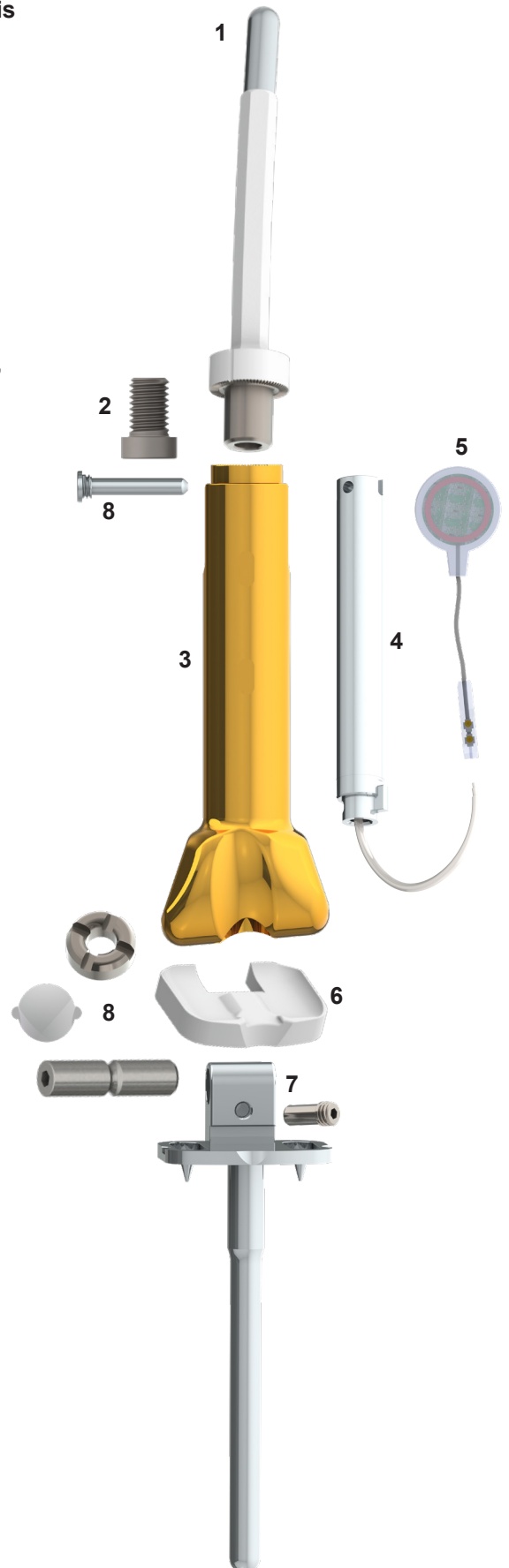

MUTARS® Xpand Proximal Femur

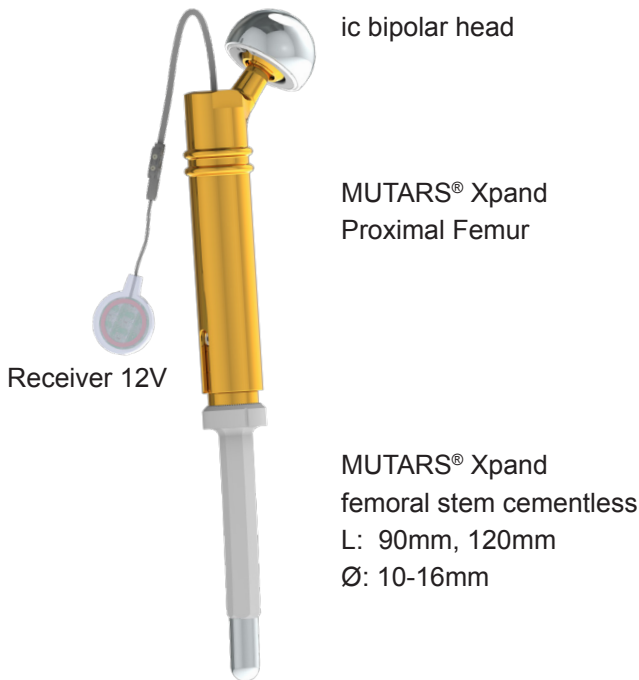

MUTARS® Xpand Proximal Femur

Indication:

Tumours or other major bone defects in growing children and youths in the area of the proximal femur including hip joint arthroplasty as hemi prosthesis or total hip replacement

System components:

MUTARS® Xpand Proximal Femur
MUTARS® Xpand extension piece,
MUTARS® Xpand bar screw,
MUTARS® Xpand femoral stem cementless,
MUTARS® TAM*,
receiver 12V*

*those components are manufactured by WITTENSTEIN intens GmbH

Length of reconstruction and possible elongation:

180mm → 50mm
205mm → 75mm
230mm → 100mm

Materials:

implatan® TiAl₆V₄

MUTARS® Xpand Distal Femur

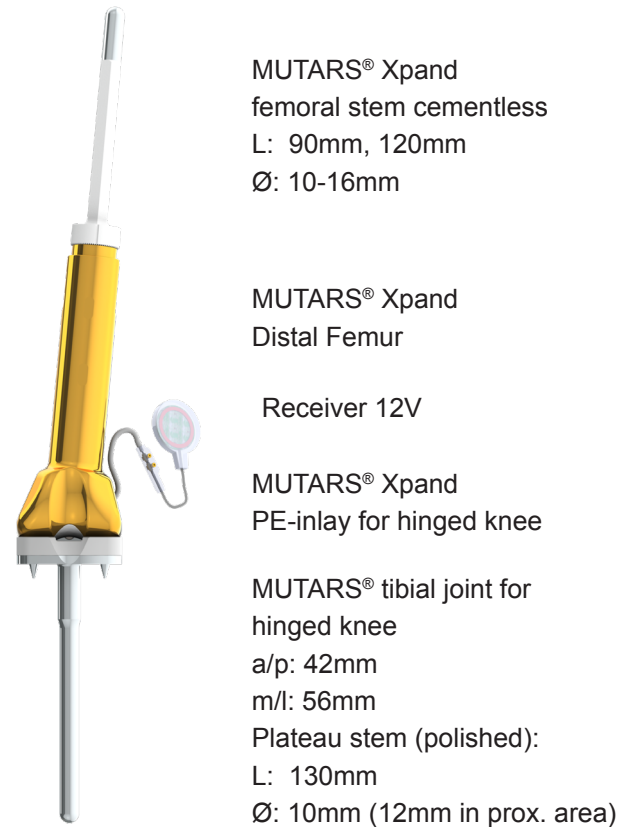

MUTARS® Xpand Distal Femur

Indication:

Tumours or other major bone defects in growing children and youths in the area of the distal femur with major femoral bone loss

System components:

MUTARS® Xpand femoral stem cementless,
MUTARS® Xpand extension piece,
MUTARS® Xpand bar screw,
MUTARS® Xpand Distal Femur
MUTARS® Xpand PE-inlay for hinged knee,
MUTARS® tibial joint f. hinged knee incl. locking bolt,
MUTARS® TAM*,
receiver 12V*

*those components are manufactured by WITTENSTEIN intens GmbH

Length of reconstruction and possible elongation:

170mm → 50mm
195mm → 75mm
220mm → 100mm

Materials:

implatan® TiAl₆V₄, implavit® CoCrMo, UHMW-PE

MUTARS® Xpand Proximal Tibia

MUTARS® Xpand Prox. Humerus



MUTARS® Xpand Proximal Tibia

Indication:

Tumours or other major bone defects in growing children and youths in the area of the proximal tibia with major femoral bone loss

System components:

MUTARS® Xpand femoral joint incl. axle,
MUTARS® Xpand PE-inlay for hinged knee,
MUTARS® Xpand proximal tibia
MUTARS® Xpand extension piece,
MUTARS® Xpand bar screw,
MUTARS® Xpand tibial stem cementless,
MUTARS® TAM*,
receiver 12V*

*those components are manufactured by WITTENSTEIN intens GmbH

Length of reconstruction and possible elongation:

170mm → 50mm
195mm → 75mm
220mm → 100mm

Materials:

implatan® TiAl₆V₄, implavit® CoCrMo, UHMW-PE

MUTARS® Xpand Proximal Humerus

Indication:

Tumours or other major bone defects in growing children and youths in the area of the proximal humerus with major humeral bone loss

System components:

MUTARS® Xpand hum. rep. CTA cap,
MUTARS® Xpand hum. rep. proximal part,
MUTARS® Xpand hum. rep. distal part,
MUTARS® Xpand humerus screw
MUTARS® Xpand humerus stem cementless
MUTARS® TAM*,
receiver 12V*

*those components are manufactured by WITTENSTEIN intens GmbH

Length of reconstruction and possible elongation:

approx. 165mm → 50mm

Materials:

implatan® TiAl₆V₄

MUTARS® Xpand Implants

MUTARS® Xpand Proximal Femur

mat.: implatan® with TiN coating

5710-1170 170mm

5710-1190 195mm

5710-1220 220mm



MUTARS® Xpand Proximal Femur accessory kit

5720-8103

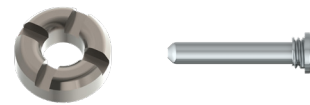

MUTARS® Xpand motor dummy

for TAM 1650 / 1675 / 16100

5720-8200 TAM 1650 50mm

5720-8201 TAM 1675 75mm

5720-8202 TAM 16100 100mm



Note:

Please notice that the amount of implants and instruments sent with any individual shipment may differ from the information provided in this brochure. Please make sure, during the preoperatively planning, that all necessary implants and instruments are available for the surgery.

All MUTARS® Xpand implants are custom-made. The mentioned REF numbers are examples that describe the general specification. The special design of the implants is determined individually and may lead to different REF numbers.

MUTARS® Xpand Implants

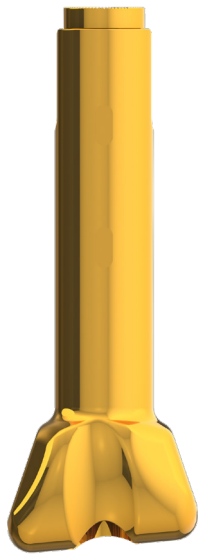

MUTARS® Xpand Distal Femur

mat.: implatan® with TiN-coating

5720-7160 left 160mm

5720-7185 left 185mm

5720-7210 left 210mm

5720-6160 right 160mm

5720-6185 right 185mm

5720-6210 right 210mm



MUTARS® tibial joint for hinged knee incl. locking bolt

mat.: implavit®

5720-8210

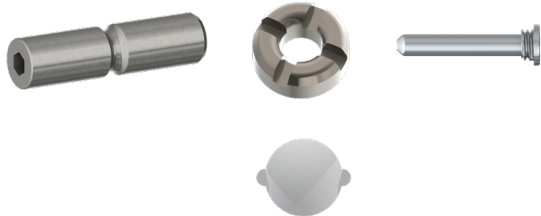

MUTARS® Xpand Distal Femur accessory kit

5720-8101 left

5720-8100 right



MUTARS® Xpand PE-inlay for hinged knee

mat.: UHMW-PE

5721-0005

MUTARS® Xpand Implants

MUTARS® Xpand femoral joint incl. axle

mat.: implatan® with TiN coating, implavit®

5720-2105 left

5720-2110 right



MUTARS® Xpand proximal tibia

mat.: implatan® with TiN coating

5720-4160 160mm

5720-4185 185mm

5720-4210 210mm

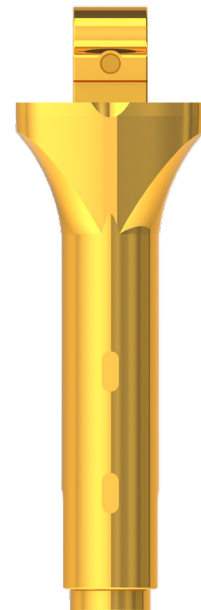

MUTARS® Xpand proximal tibia accessory kit

5720-8102

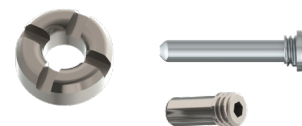

MUTARS® Xpand PE-inlay for hinged knee

mat.: UHMW-PE

5721-0005

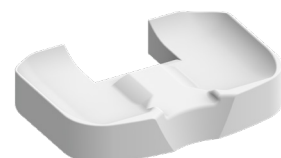

MUTARS® Xpand Implants



MUTARS® Xpand extension piece

mat.: implatan®

5772-8304 40mm

5772-8306 60mm

5772-8308 80mm



MUTARS® Xpand reducer piece

mat.: implatan®

5730-8220 20mm

5730-8230 30mm



MUTARS® Xpand bar screw

mat.: implatan®

5720-8015 M10x 15mm

5720-8055 M10x 55mm

5720-8075 M10x 75mm

5720-8095 M10x 95mm



MUTARS® Xpand femoral stem cementless

mat.: implatan® with HA coating

REF	diameter	length
5720-8110	10mm	120mm
5720-8111	11mm	120mm
5720-8112	12mm	120mm
5720-8113	13mm	120mm
5720-8114	14mm	120mm
5720-8115	15mm	120mm
5720-8116	16mm	120mm
5720-9110	10mm	90mm
5720-9111	11mm	90mm
5720-9112	12mm	90mm
5720-9113	13mm	90mm
5720-9114	14mm	90mm
5720-9115	15mm	90mm
5720-9116	16mm	90mm

MUTARS® Xpand Implants

MUTARS® Xpand tibial stem cementless

mat.: implatan® with HA coating

REF	diameter	length
5720-8310	10 mm	120mm
5720-8311	11 mm	120mm
5720-8312	12 mm	120mm
5720-8313	13 mm	120mm
5720-8314	14 mm	120mm
5720-8315	15 mm	120mm
5720-8316	16 mm	120mm
5720-9310	10 mm	90mm
5720-9311	11 mm	90mm
5720-9312	12 mm	90mm
5720-9313	13 mm	90mm
5720-9314	14 mm	90mm
5720-9315	15 mm	90mm
5720-9316	16 mm	90mm

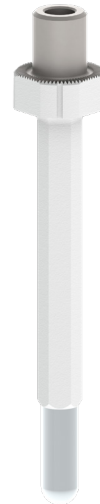

MUTARS® TAM 16 special design*

6000-0870	1650	50mm
6000-0885	1675	75mm
6000-0886	16100	100mm

*manufactured by WITTENSTEIN intens GmbH



receiver 12V*

6000-1615

*manufactured by WITTENSTEIN intens GmbH



Material and coating catalogue

materials:

implatan® TiAl ₆ V ₄	acc. to ISO 5832-3
implavit® CoCrMo	acc. to ISO 5832-4
implavit® CoCrMo	acc. to ISO 5832-12
UHMW-PE	acc. to ISO 5834-2

coatings:

implaFix® HA (hydroxyl apatite coating)	acc. to ISO 13779-2
TiN coating (titanium nitride coating)	

MUTARS® Xpand Instruments



torque wrench (sterile)
6000-1622



Raucodrape® (sterile)
6000-1562



stethoscope (non-sterile)
6000-0676



**MUTARS® Xpand control unit
incl. transmitter head (non-sterile)***
6000-1524 (control unit + transmitter head)
6000-1365 (only control unit)
6000-1149 (only transmitter head)



*manufactured by WITTENSTEIN intens GmbH

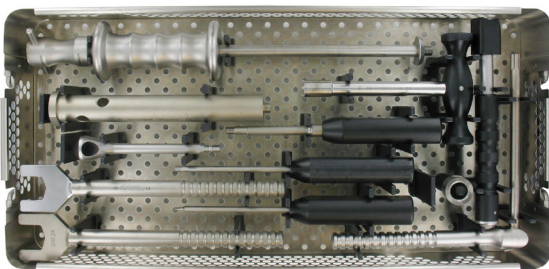

MUTARS® Xpand basic container
7999-5780

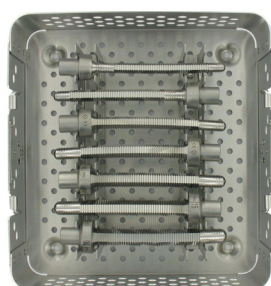

MUTARS® Xpand rasp container
7999-5781 tibial rasps
7999-5782 femoral rasps



implantcast

implantcast GmbH
Lüneburger Schanze 26
D-21614 Buxtehude
Germany
phone: +49 4161 744-0
fax: +49 4161 744-200
e-mail: cfit3d@implantcast.de
internet: www.implantcast.de



your local distributor:



MUGROWPE-181218

